

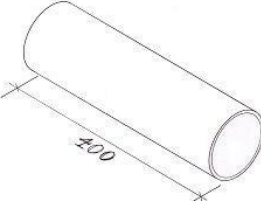

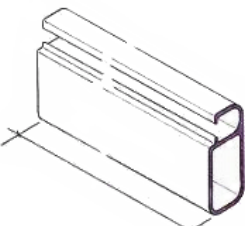

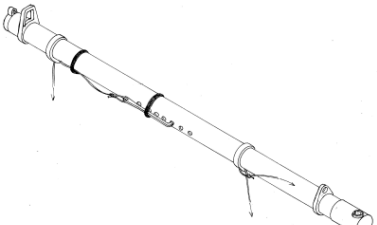



**FITTINGS Y ACCESORIOS
PARA VELA
RADIOCONTROLADA**

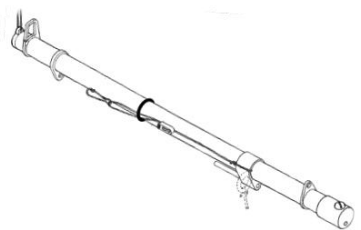
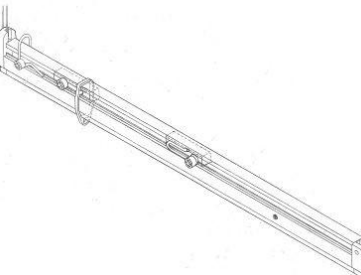
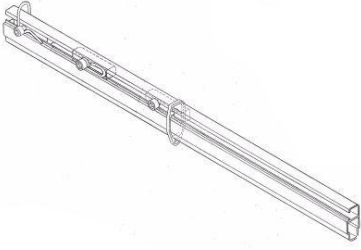
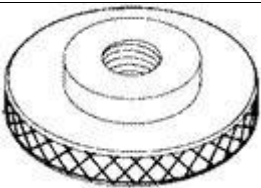

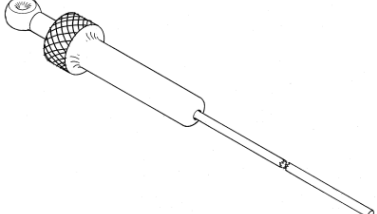
Graham Bantock
SAILSetc

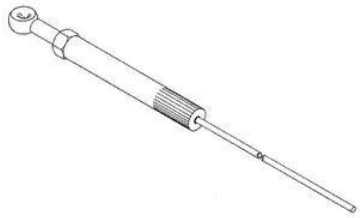
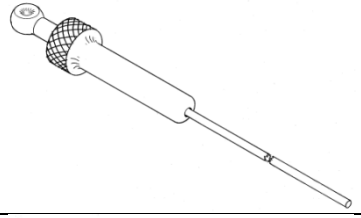
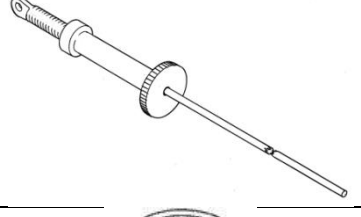
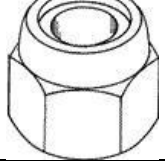
	CODIGO	DESCRIPCION	PRECIO
	AR-110	Alloy round - 11.0 mm (7/16 in) diam.	\$32.000
	AR-128	Alloy round - 12.8 mm (1/2 in) diam.	\$32.000
	SPAR-LW-400	Alloy boom spar - lightweight - 400 mm	\$4.500
	SPAR-SE	Alloy boom spar - SAILSetc section - natural	\$8.700
	SPAR-SE-COL	Alloy boom spar - SAILSetc section - black or gold	\$10.100
	BOOM-H-110	Headsail boom - 11 mm diam alloy tube	14.750
	BOOM-M-110	Ki botavara redonda 11mm y fittings para mayor (No incluye fitting a boomvang)	8.750

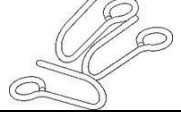
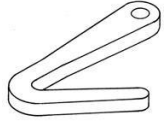
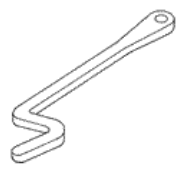
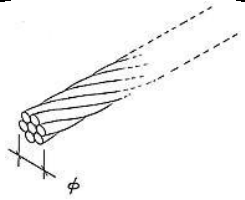
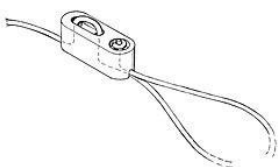

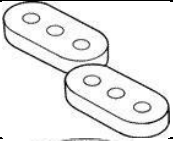
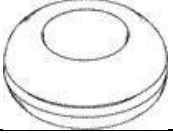
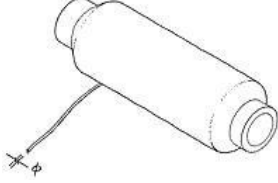
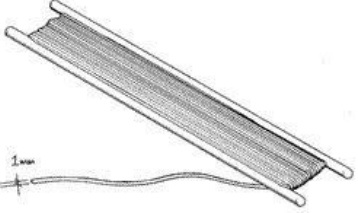
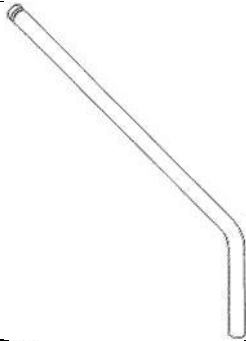
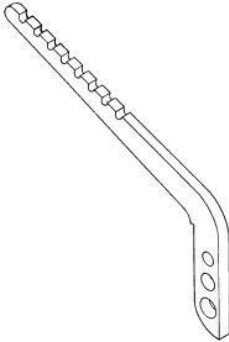
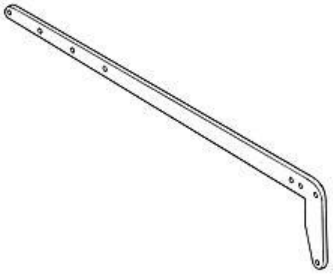
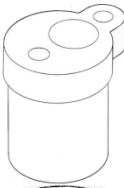
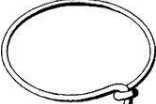
	BOOM-H-LW	Headsail boom –lightweight	13.200
	BOOM-H-SE	Kit sencillo botavara rectangular de foque y fitting	17.200
	BOOM-M-SE	Kit botavara rectangular y fitnngs para mayor	14.750
	FIT-H-110	Kits de fittings para botavara de foque 11mm	8.750
	FIT-M-110	Kit de fittings para botavara mayor 11mm (no incluye fitting a boomvang)	3.550
	FIT-H-LW	Kit de fittings para botavara de foque light 10mm	8.200
	FIT-H-SE	Kit de fittings para botavara de foque rectangular	10.100
	FIT-M-SE	Kit de fittings para botavara mayor rectangular (no incluye fitting a boomvang)	7.650
	026-WHEEL	Tuerca de ajuste de bommvang 4mm	
	030-020	Riggingscrew micro (Rg 65, Victoria)	3.700
	030-030	Riggingscrew 3mm	3.100
	030-030SL	Riggingscrew 3mm autobloqueante	3.931

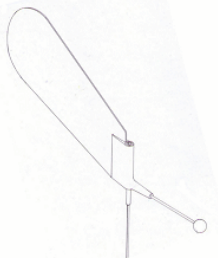
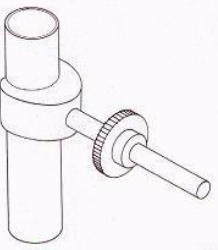
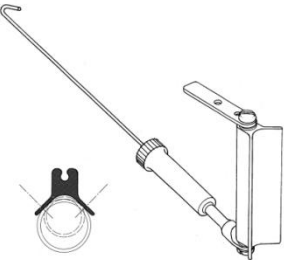
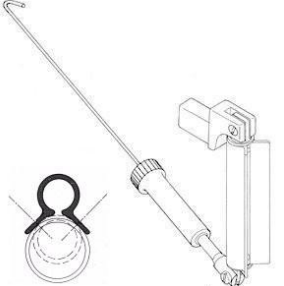
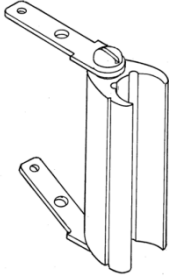
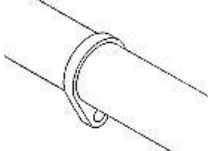
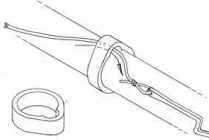
	030-035	Riggingscrew 3.5mm	3.300
	030-035SL	Riggingscrew 3.5mm autobloqueante	4.000
	030-040	Riggingscrew tensor de boomvang 4mm	7.650
	031B	Tuercas autobloqueantes 3mm (20 un.)	2.750
	070-012	Crimps para obenques de acero small(12)	1.970
	070-016	Crimps para obenques de acero médium (12)	2.200
	085	Argolla para conectar obenque y tensor de vela mayor	1.750
	087B	Ganchos de acero inoxidable (10)	4.000
	087G	Gancho de acero CNC para arraigo de foque chico	1.350
	087H	Gancho de acero CNC para arraigo de foque grande	1.350
	087Z	Gancho CNC para escotas	1.350
	W045	Cable de 7 ebras acero inox. forrado en plástico 0.40mm (10 mt.)	8.000
	057B	Bowsiesmedium (10)	3.500
	057C	Bowsieslarge (10)	3.200

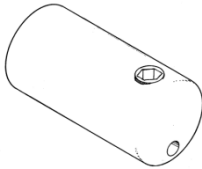
	<p>057X</p> <p>057XX</p>	<p>Bowsies micro (10)</p> <p>Bowsies micro (20)</p>	<p>3.000</p> <p>4.350</p>
	<p>058</p>	<p>Grommets 8mm</p> <p>Grommets 10-11mm</p>	<p>\$4.000</p> <p>\$4.400</p>
		<p>Escotas Multifilamento: (10 metros)</p> <p>45 kg.</p> <p>30kg.</p> <p>12kg.</p>	<p>\$5.000</p> <p>\$3.000</p> <p>\$3.000</p>
	<p>E20</p>	<p>Silicona 2mm heavy duty para tensar escota de velas al servo</p>	<p>2.800</p>
	<p>022</p>	<p>Mastcrane 6mm dual. Anodizado negro</p>	<p>4.100</p>
	<p>022-040</p>	<p>Mastcrane 40mm CNC. acero inoxidable</p>	<p>3.000</p>
	<p>022-VIC</p>	<p>Mastcrane Victoria CNC</p>	<p>3.300</p>
	<p>023-110</p>	<p>Tope de Mastil para 11mm</p> <p>Tope de Mastil para 12,7mm</p>	<p>1.500</p> <p>1.500</p>
	<p>0.51</p>	<p>Argolla para vela mayor a m{astiles 11mm y 12,7mm</p>	<p>600</p>

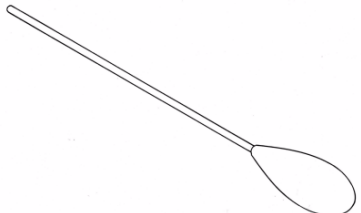
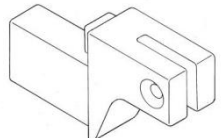
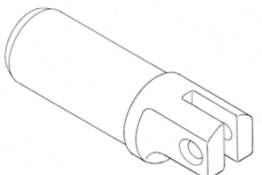
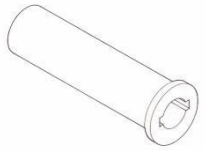
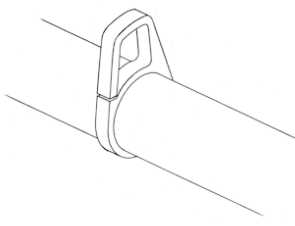
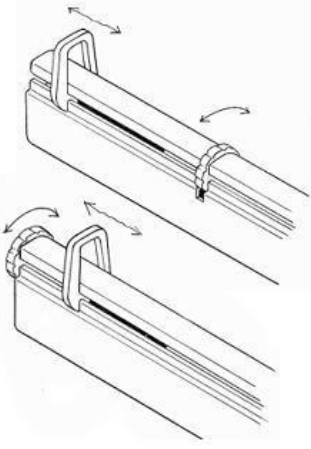
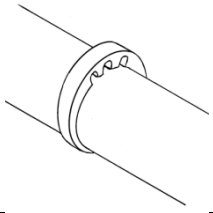
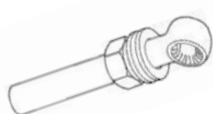
	100	Veleta	18.300
	140-110	Mast ram para mástil 11mm	9.800
	5	Boomvang 5cms alto	18.291
	11C	Boomvang con rodamiento (incluye fitting para botavara cuadrada) Debe agregarse fitting para botavara redonda en 10 u 11mm	45.318
	015RG	Boomvang para mástil 8-9 mm (rg 65 y Victoria)	15.000
	046-110-LOCK	Fitting pasa escota 11mm	2.500
	048-100	Boom Band para pasar escota	950
	082-010	Orings 10mm para fijar ganchos de escotas (10)	1.550
	101-100 101-110	Tope frontal botavara de foque. hembra	2.500 3.550

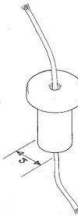
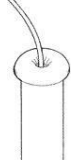
	102	Contrapeso plomo 25 grms.	5.200
	103B	Fiting frontal botavara mayor rectangular. Con diseño para bajar altura de botavara. (yo la modifico para usar en botavaras redondas también)	2.800
	103C	Fiting frontal botavara mayor dedonda en 10 u 11mm	2,800
	103F	Fiting de botavara 10mm light mayor a boomvan Fiting de botavara 11mm mayor a boomvang	1.500 2.200
	105	Sujeta puño de vela 10 u 11mm	1,500
	105-SE	Ajuste de camber para botavaras rectangulares (1 un.)	8.700
	106	Fiting anclaje de estay de proa al mástil y pasa escta que tensa puño delantero del foque	1.100
	035-020	Eyebolt 3mm	1.650
	035-025	Eyebolt 3.5mm	1.750

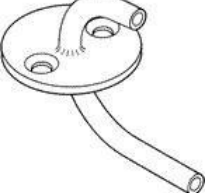
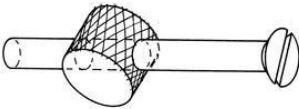





	052	Poste con tubo para posicionar escota	8.500
	052-003	Pasa escotas de teflón 3mm	1.900
	052-006	Pasa escotas 6mm	1.350
	053	Anillo de teflón pasa escotas	1.500
	060A	Pasa escota a través de cubierta	14.200
	INS-040	Tuerca inserta y perno para sujetar quilla	3.300

"All drawings are copyright of www.sailsetc.com and are reproduced here with their permission"
 "Todas las ilustraciones son propiedad de www.sailsetc.com y son reproducidas aquí con su permiso"

		VELAS 1METRO ULY	
		A	\$35.000
		B	\$32.000
		C	\$30.000



	CODIGO	DESCIPCION	PRECIO
		Gancho escota grande	2.500
		Gancho escota chico	2.500
		Riggingscrew 3mm (2)	3.750
		Botavara 10mm ultra light	8.200
		Botavara 11mm anodizada negro	7.000
		Contrapesos cubiertos en silicona	7.000

		<p>Arraigo de foque a cubierta</p>	<p>10.500 10mm</p> <p>11.500 11mm</p>
		<p>Anillo trasero de botavara de foque para pasar el amantillo</p>	<p>10mm 4.500</p> <p>11mm 5.000</p>
		<p>Fitting frontal de foque para sujetar estay de proa</p>	<p>10mm 5.500</p> <p>11mm 6.500</p>
		<p>Fitting arrigo de escota. Regulable</p>	<p>10mm 4.500</p> <p>11mm 5.500</p>
		<p>Fitting pasa escota. Regulable</p>	<p>10mm 4.500</p> <p>11mm 5.500</p>
		<p>Anillo pasa escota</p>	<p>10mm 2.000</p> <p>11mm 2.300</p>
		<p>Sujeta puño de vela. Regulable</p>	<p>10mm 7.000</p> <p>11mm 8.500</p>







	Codigo	Descripción	Precio
		Botavara con rodamientos	32.000
		Fitting frontal de foque, con sujeta estay de proa 10mm / 11mm	2.500
		Riggingscrew 3mm con tuerca autobloqueante (2)	6.500
		Fitting sujeta puño de vela 10mm /11mm	2.500
		Anillo pasa escota 10mm / 11mm	2.500
		Polea simple inoxidable 10mm	10.000

			Polea doble 10mm inoxidable	12.000
			Polea simple 8mm inoxidable	8.500
			Polea fija 8mm inoxidable Polea fija 10mm inoxidable	9.000 10.500
			Polea fija doble 10mm inoxidable	12.000
			Bulbo rg 65	20.000 más flete a Chile
			Bolsa para aparejos IOM /1Metro ULY	90.000
			Timonrg 65	18.000

		Bulbo IOM	40.000 más flete a Chile
		Servo winche S-125	38.000
VELAS: FLETE A CHILE \$24.000 DE 1 A 3 APAREJOS		VELA CLASSE iom RIG A 50/50onix	76.000
		VELA CLASSE iom RIG A 50/36 Onix	79.000
		VELA CLASSE iom RIG B 50/50 Onix	64.000
		VELA CLASSE iom RIG B 75/50 Onix	65.000
		VELA CLASSE iom RIG C 75/75	59.000
		Tubo para escotas	11.500

RMG SMARTWINCH

	290 EL	Winche IOM / 1 metro ULY (Precio incluye AU\$25.00 de flete a Chile)	\$152.900
	290 EF		\$157.100
	290 ES		\$153.500
		Rgmswitchfutaba	\$23.000
	32stL	Tambor autotensante giro a izquierda	\$11.200

	32stR	Tambor autotensante giro a derecha	\$11.200
---	-------	------------------------------------	----------

Use the drawing to identify the part required then go to the table below the drawing and knowing the winch model the part is required for, click on the part and you will be taken to that part's page so that it can be placed in the shopping cart. If multiple parts required, after entering a part into the shopping cart, select to continue shopping.

	280						280, 290			380							
	SW	C	D	DL	ES	EL	EF	ES	EL	SW	C	D	HD	ES	EH	EL	
1	NA						MP290EF	MP290ES	MP290EL	NA	MP380					MP380EL	
2	290M									380M							
3	CS																
4	FE1 (glued controller box models)						FE2	FE3		FE1			FE4				
5	NA	10TP					5TP	10TP									
6	NA	PSp															
7	NA	PN (supplied with item 5)															
8	NA	PSe															
9	NA	PG30	PG26	PG30			PG26	PG30	PG30	PG48	PG30	PG48					
10	GA16	GA20	GA16	GA20	GA16	GA18	GA20	GA16	GA320				GA316				
11	GB						GBF	GB									
12	GC						GCF	GC			GC3						
13	GD						GDF	GD			GD3						
14	TS																
15	M3x25CSK																
16	M3x8PAN																
17	M3x4PAN (For 290 motor only)									M2.5x5PAN							
18	M3NUT																
19	M3W																
20	NA						2x9ST (supplied with CBR6)			NA			2x9ST (supplied with CBR6)				
21	CBR3 (glued controller box)						CBR6 *			CBR3 (glued controller box)			CBR6				
22	26s						32s			26s			26s	32s	32w	32s	32w

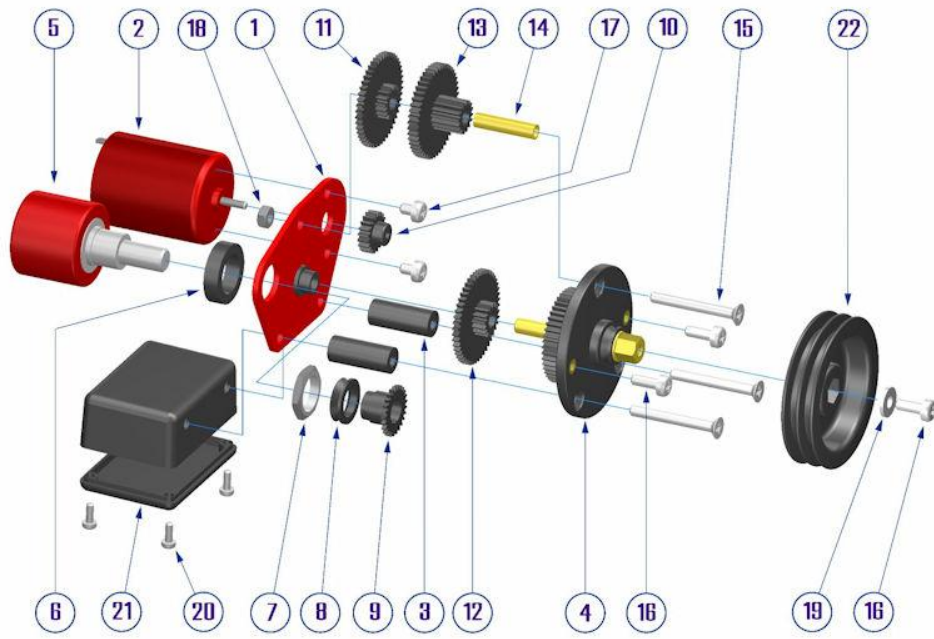

<p>A Turnigy 6-channel radio transmitter and receiver. The transmitter is black and blue, featuring two joysticks, several buttons, and a small LCD screen. The receiver is a small green PCB with a black antenna wire attached.</p>	<p>Radio 6 canales con receptor:</p>	<p>\$60.000</p>
---	--------------------------------------	-----------------